

# IR ENERGY LUXURY OUTDOOR COLLECTION

even**TUBE**® | even**GLO**® | the **Habanero**® | e**WAVE**™



USD Price List, Oct 1st, 2024



# Table of Contents



**evenGLO®**

.....Page 3 - 7

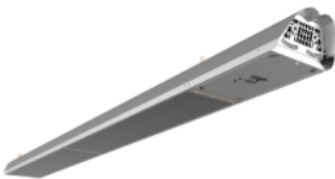

**evenTUBE®**

.....Page 8 - 12



**the Habanero®**

.....Page 13 -16



**eWAVE™**

.....Page 17

## HEAD OFFICE

563 Barton Street  
Stoney Creek ON L8E 5S1

## US FACTORY

315 N Madison Street  
Fortville, IN 46040

## CONTACT US

1 905 664 9082  
info@irenergy.ca



A true commercial grade, infrared heating solution you can always depend on for reliability and longevity.

- 3 years warranty - Best in class
- 58% more heat coverage than our top competitor
- Provides comfort to spaces within 20-24 ft in diameter
- Aesthetically appealing with mesmerizing glow
- Individual or multi heater zoning capabilities with two stage controls

**Confidential USA List Price—Effective Oct 1st, 2024**

	316 MG S/S		Black Finish		Bronze Finish	
<b>Model GA201M2</b> Portable Propane Patio Heater 46,000 BTU/hr Propane fueled Safety shut off tilt switch Includes durable wheel kit Easy access tank switch-outs						
<b>SRP Part Number</b>	<b>E202PS</b>		<b>E202PBLJ</b>		<b>E202PBRM</b>	
<b>List Price</b>	\$4,588.50		\$4,180.00		\$4,180.00	
<b>Model GA301MP</b> Portable Natural Gas or Propane Patio Heater for applications with a fixed gas supply 53,000 BTU/hr Includes durable wheel kit Choose from 12' or 15' hose kits with quick disconnects						
<b>SRP Part Number</b>	<b>E202NS12</b>	<b>E202NS15</b>	<b>E202NBL12</b>	<b>E202NBL15</b>	<b>E202NBR12</b>	<b>E202NBR15</b>
<b>List Price</b>	\$4,892.00	\$4,908.00	\$4,331.80	\$4,370.60	\$4,331.80	\$4,370.60
<b>Model GA301M &amp; GA301T&amp;U</b> Floor Mounted Fixed Patio Heater 53,000 BTU/hr Propane or Natural Gas options Operating with 24V or Manual Equipped with a welded flange suitable for four bolt mounting						
	<b>Part # with T has 75" pole, without T has standard 63" pole</b>					
<b>SRP Part Number (Manual Ignition)</b>	<b>E301NMS</b>	<b>E301NMST</b>	<b>E301NMBL</b>	<b>E301NMBLT</b>	<b>E301NMBR</b>	<b>E301NMBRT</b>
<b>List Price</b>	\$3,297.10	\$3,499.00	\$3,158.00	\$3,256.00	\$3,158.00	\$3,256.00
<b>SRP Part Number (24V H/L Direct Ignition)</b>	<b>E301NUS</b>	<b>E301NTS</b>	<b>E301NUB</b>	<b>E301NTBL</b>	N/A	
<b>List Price</b>	\$3,297.10	\$3,395.30	\$3,054.00	\$3,151.00	N/A	
<b>Model GA301H</b> The hanging mushroom gas patio heater 53,000 BTU/hr Propane or Natural Gas options					For Model GA301MP, M, T, U, H please replace "N" in the part no to "P" for LPG version	
<b>SRP Part Number (24V H/L Direct Ignition)</b>	<b>E301NHS</b>		<b>E301NHB</b>		N/A	
<b>List Price</b>	\$3,720.40		\$3,260.60		N/A	

## HEAD OFFICE

563 Barton Street  
 Stoney Creek ON L8E 5S1

## US FACTORY







315 N Madison Street  
 Fortville, IN 46040

## CONTACT US

1 905 664 9082  
 info@irenergy.ca

**Confidential USA List Price—Effective Oct 1st, 2024**

**Accessories**

Image	Part	Description	Compatible	Price
	EH105	All season cover	All Models	\$304.40
	SE004	Transformer 120/24V, 20VA for 1 heater Class 2 Not Wet, Class 3 Wet	GA301U/T/H	\$43.30
	SE009	Transformer 120/24V, 40VA for 2 heaters	GA301U/T/H	\$57.60
	SE010	Transformer 120/24V, 100VA for up to 5 heaters	GA301U/T/H	\$149.90
	EE020	Two Stage Control Switch, 24V (fixed mount, 3x3x3") <b>Weather resistant for NEMA-4 Applications</b>	GA301U/T/H	\$328.40
	EE065	Two Stage Control Switch, 24V, <b>1 Switch</b> . Control up to 5 heaters (Ideal for covered patios applications)	GA301U/T/H	\$402.70
	EE066	Two Stage Control Switch, 24V, <b>2 Switches</b> . Control up to 5 heaters (Ideal for covered patios applications)	GA301U/T/H	\$671.40
	EE067	Two Stage Control Switch, 24V, <b>1 Switch, with Timer</b> . Control up to 5 heaters (Ideal for covered patios applications)	GA301U/T/H	\$579.80
	EE068	Two Stage Control Switch, 24V, <b>2 Switches, with Timers</b> . Control up to 5 heaters (Ideal for covered patios applications)	GA301U/T/H	\$962.90
	ES082	Gas Connection Cover - 304 Stainless Steel	GA301U/T/M	\$166.70
	ES117	Gas Connection Cover - Powder Coat, Jet Black	GA301U/T/M	\$207.70
	ES234	Gas Connection Cover - Powder Coat, Med Bronze	GA301U/T/M	\$213.50

**HEAD OFFICE**

563 Barton Street  
Stoney Creek ON L8E 5S1

**US FACTORY**

315 N Madison Street  
Fortville, IN 46040

**CONTACT US**

1 905 664 9082  
info@irenergy.ca

**Confidential USA List Price—Effective Oct 1st, 2024**

**Replacement Parts Model GA201M2**

Item	Part	Description	WGT (lbs)	List Price
1	RP-ES170S	Pole Neck, 316 Stainless Steel	1	\$268.40
	RP-ES170BRM	Pole Neck, Medium Bronze	1	\$255.60
	RP-ES170BLJ	Pole Neck, Jet Black	1	\$255.60
2	RP-ES171S	Tank Housing Top Cover, 316 Stainless Steel	N/A	\$279.60
	RP-ES171BRM	Tank Housing Top Cover, Medium Bronze	N/A	\$216.80
	RP-ES171BLJ	Tank Housing Top Cover, Jet Black	N/A	\$216.80
3	RP-ES172S	Pole Assembly, 316 Stainless Steel	N/A	\$254.10
	RP-ES172BRM	Pole Assembly, Medium Bronze	N/A	\$219.10
	RP-ES172BLJ	Pole Assembly, Jet Black	N/A	\$219.10
4	RP-ES011	Emitter Assembly	1.5	\$325.10
5	RP-EH016	Knob / Comfort Control Dial	0.1	\$52.80
6	RP-EH046	Tank Housing Handle with Hardware	N/A	\$41.00
7	RP-EH066	Wheel Assembly Kit S/S with hardware	N/A	\$221.80
9	RP-ES145S	Arm Assembly w/Shield Support & Hardware, 316 S/S	N/A	\$116.30
10	RP-ES161S	Tank Housing, 304 Stainless Steel	N/A	\$389.80
	RP-ES161BRM	Tank Housing, Medium Bronze	N/A	\$515.70
	RP-ES161BLJ	Tank Housing, Jet Black	N/A	\$515.70
11	RP-ES168S	Bottom Base, 304 Stainless Steel	N/A	\$511.20
	RP-ES168BRM	Bottom Base, Medium Bronze	N/A	\$405.10
	RP-ES168BLJ	Bottom Base, Jet Black	N/A	\$405.10
12	RP-EE034	Tilt Safety Switch with Hardware	0.1	\$79.70
13	RP-EE028	Battery Igniter	0.1	\$41.10
14	RP-EG036	Gas Valve w/fittings and Orifice LPG	1	\$246.60
15	RP-EG038	Thermocurrent Interrupter Block 11/32"	0.1	\$51.40
16	RP-EG068	Pilot Assembly LPG w/Thermocouple, SS Tube & Hardware	1	\$260.60
17	RP-EE038	Thermocouple 24"	1	\$82.20
18	KG015	2 Breakaway Pilot Nuts	N/A	\$6.70
19	RP-EG042	S/S Flexible Pilot Tube with 2 Breakaway Pilot Nuts	1	\$54.90
20	RP-EG056	Propane Gas Regulator with Quick Disconnect (GA201M2)	N/A	\$108.00
21	ES041	Top Reflector Package with Hardware	12	\$230.10
22	RP-ES233A	Outer Shield 316 Marine Stainless Steel (ES080 is obsolete)	1	\$154.70
23	ES210PS	Heater Head Package S/S LPG	N/A	\$2,712.00
	ES210PBRM	Heater Head Package Medium Bronze LPG	N/A	\$2,696.50
	ES210PBLJ	Heater Head Package Jet Black LPG	N/A	\$2,684.60

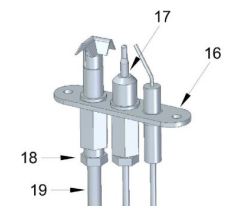
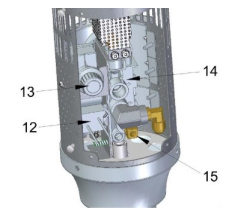
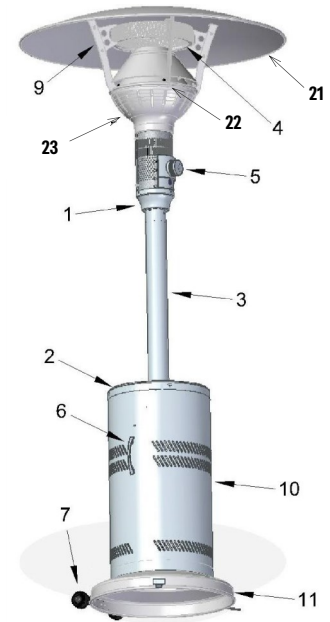

## HEAD OFFICE

563 Barton Street  
Stoney Creek ON L8E 5S1

## US FACTORY

315 N Madison Street  
Fortville, IN 46040

## CONTACT US

1 905 664 9082  
info@irenergy.ca



**Confidential USA List Price – Effective Oct 1st, 2024**

**Replacement Parts Models GA301M (Fixed) & GA301MP (Portable)**

Item	Part	Description	WGT. (lbs)	List Price
1	RP-ES170S	Pole Neck, 316 Stainless Steel	1	\$268.40
	RP-ES170BRM	Pole Neck, Medium Bronze	1	\$255.60
	RP-ES170BLJ	Pole Neck, Jet Black	1	\$255.60
2	RP-ES171S	Tank Housing Top Cover, 316 Stainless Steel	N/A	\$279.60
	RP-ES171BRM	Tank Housing Top Cover, Medium Bronze	N/A	\$216.80
	RP-ES171BLJ	Tank Housing Top Cover, Jet Black	N/A	\$216.80
3	ES312S	Pole Package <b>63"</b> , 316 Stainless Steel	N/A	\$796.80
	ES312BRM	Pole Package <b>63"</b> , Medium Bronze	N/A	\$736.80
	ES312BLJ	Pole Package <b>63"</b> , Jet Black	N/A	\$736.80
	ES313S	Pole Package <b>75"</b> , <b>TALL*</b> 316 Stainless Steel (GA301M only)	N/A	\$827.80
	ES313BRM	Pole Package <b>75"</b> , <b>TALL*</b> Medium Bronze (GA301M only)	N/A	\$793.00
	ES313BLJ	Pole Package <b>75"</b> , <b>TALL*</b> Jet Black (GA301M only)	N/A	\$793.00
4	RP-ES011	Emitter Assembly	1.5	\$325.10
5	RP-EH016	Knob / Comfort Control Dial	0.1	\$52.80
7	RP-EH066	Wheel Assembly w/bearing (GA301MP)	N/A	\$221.80
9	RP-ES145S	Arm Assembly w/Shield Support & Hardware, 316 S/S	N/A	\$116.30
10	RP-ES215SM	Base Housing, 304 Stainless (GA301MP)	N/A	\$236.00
	RP-ES215BRM	Base Housing, Medium Bronze (GA301MP)	N/A	\$214.60
	RP-ES215BLJ	Base Housing, Jet Black (model GA301MP)	N/A	\$214.60
11	RP-ES168S	Bottom Base, 304 Stainless Steel (GA301MP)	N/A	\$511.20
	RP-ES168BRM	Bottom Base, Medium Bronze (GA301MP)	N/A	\$405.10
	RP-ES168BLJ	Bottom Base, Jet Black (GA301MP)	N/A	\$405.10
12	RP-EE034	Tilt Safety Switch with Hardware	0.1	\$99.70
13	RP-EE028	Battery Igniter	0.1	\$41.10
14	RP-EG036	Gas Valve w/fittings and Orifice LPG	1	\$246.60
	RP-EG037	Gas Valve w/fittings and Orifice NG	1	\$246.60
15	RP-EG038	Thermocurrent Interrupter Block 11/32"	0.1	\$51.40
16	RP-EG067	Pilot Assembly NG w/Thermocouple, SS Tube & Hardware	1	\$199.70
	RP-EG068	Pilot Assembly LPG w/Thermocouple, SS Tube & Hardware	1	\$260.60
17	RP-EE038	Thermocouple 24"	1	\$82.20
18	KG015	2 Breakaway Pilot Nuts	N/A	\$6.70
19	RP-EG042	S/S Flexible Pilot Tube with 2 Breakaway Pilot Nuts	1	\$54.90
20	RP-EG063	Natural Gas Regulator with Quick Disconnect Kit	N/A	\$224.50
	RP-EG147	LPG Regulator with Quick Disconnect kit	N/A	\$303.40
21	ES041	Top Reflector Package with Hardware	12	\$230.10
22	RP-ES233A	Outer Shield 316 Marine Stainless Steel (ES080 is obsolete)	1	\$154.70
23	ES310NS	Heater Head Package S/S Nat Gas	N/A	\$2,634.20
	ES310NBRM	Heater Head Package Medium Bronze Nat Gas	N/A	\$2,671.30
	ES310NBLJ	Heater Head Package Jet Black Nat Gas	N/A	\$2,671.30
	ES310PS	Heater Head Package S/S LPG	N/A	\$2,634.20
	ES310PBRM	Heater Head Package Medium Bronze LPG	N/A	\$2,671.30
	ES310PBLJ	Heater Head Package Jet Black LPG	N/A	\$2,671.30
	ES310NST	Heater Head Package <b>TALL*</b> S/S Nat Gas	N/A	\$2,714.60
	ES310NBRMT	Heater Head Package <b>TALL*</b> Medium Bronze Nat Gas	N/A	\$2,760.90
	ES310NBLJT	Heater Head Package <b>TALL*</b> Jet Black Nat Gas	N/A	\$2,760.90
	ES310PST	Heater Head Package <b>TALL*</b> S/S LPG	N/A	\$2,714.60
	ES310PBRMT	Heater Head Package <b>TALL*</b> Medium Bronze LPG	N/A	\$2,760.90
	ES310PBLJT	Heater Head Package <b>TALL*</b> Jet Black LPG	N/A	\$2,760.90
24	EG065	Supply Hose Kit with Regulator 12' NG (GA301MP)	N/A	\$464.80
25	EG066	Supply Hose Kit with Regulator 15' NG (GA301MP)	N/A	\$515.20
24	EG072	Supply Hose Kit with Regulator 12' Propane (GA301MP)	N/A	\$538.00
25	EG145	Supply Hose Kit with Regulator 15' Propane (GA301MP)	N/A	\$581.50
-	EG053	Internal Hose 1/2" x 76" (for 63" POLE) Series GA301 Models <b>U/H/M/MP</b> (not shown)	N/A	\$137.00
-	EG071	Internal Hose 1/2" x 88" (for 75" POLE) Series GA301 Models <b>T/M Tall</b> (not shown)	N/A	\$171.20

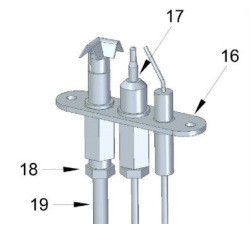
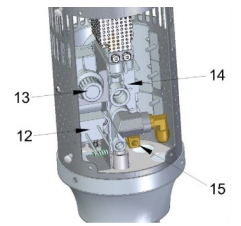
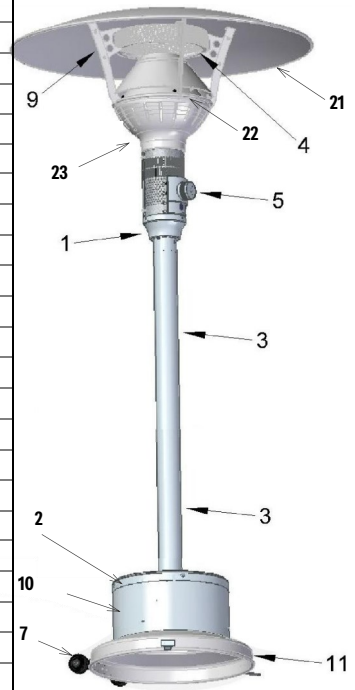

**\*For TALL Heater Pole measuring 75"**  
**from bottom flange to top of Pole Neck.**

## HEAD OFFICE

563 Barton Street  
 Stoney Creek ON L8E 5S1

## US FACTORY

315 N Madison Street  
 Fortville, IN 46040

## CONTACT US

1 905 664 9082  
 info@irenergy.ca

**Confidential USA List Price – Effective Oct 1st, 2024**

**Replacement Parts Models GA301U, GA301T, GA301H**

Item	Part	Description	WGT. (lbs)	List Price
1	ES041	Top Reflector Package	14	\$230.10
2	EG053	Internal Hose 1/2" x 76" (for 63" POLE) Series GA301 Models U/H/M/MP)	2	\$137.00
	EG071	Internal Hose 1/2" x 88" (for 75" POLE) Series GA301 Models T/M Tall)	2	\$171.20
3	RP-ES011	Emitter	15	\$325.10
4	RP-EE002	Flame Sensor	0.1	\$70.10
5	RP-EE001	Spark Electrode	0.1	\$79.20
6	RP-EE151	¥ Module, potted 24V DSI (Replaces channel 2021-154, 6 pin)	1	\$171.20
	RP-EE030	₣ Replacement Module Kit 24V (Replaces 2021-96, 5 pin)	1	\$231.30
7	EG002	Orifice—Natural Gas	0.1	\$8.50
	EG022	Orifice—LPG	0.1	\$12.00
8	RP-EG015	Gas Valve Assembly - Natural Gas (w/Orifice)	2	\$325.30
	RP-EG016	Gas Valve Assembly - LPG (w/Orifice)	2	\$325.30
N/S	EE004	Indicator Light Amber (not shown)	N/A	\$9.70
	EE010	Indicator Light Blue (not shown)	N/A	\$7.30
10	EG008	Burner Assembly w/ Flame & Spark electrodes	3	\$488.90
11	ES312BLJ	Pole Package Black 63" (Model GA301U)	23	\$736.80
	ES313BLJ	Pole Package Black 75" (Model GA301T)	23	\$793.00
	ES312S	Pole Package S/S 63" (Model GA301U)	23	\$796.80
	ES313S	Pole Package S/S 75" (Model GA301T)	23	\$827.80
N/S	RP-EE005	Ignition Wire (not shown)	0.1	\$39.90
12	RP-ES145S	Arm Assembly w/Shield Support, 316 S/S	1	\$116.30
N/A	RP-ES233A	Outer Shield 316 Marine S/S ( <b>ES080 is obsolete</b> )	1	\$154.70

**Important:** EE009 (5 pin module) has been discontinued

¥ The EE151 (6 pin) module is the replacement for GA301 24VAC models purchased **after** Aug. 1, 2021

₣ The EE030 (6 pin) kit (includes module + wire harness) replacement for GA301 24VAC models purchased **before** Aug. 1, 2021

**Models GA301U and GA301T**

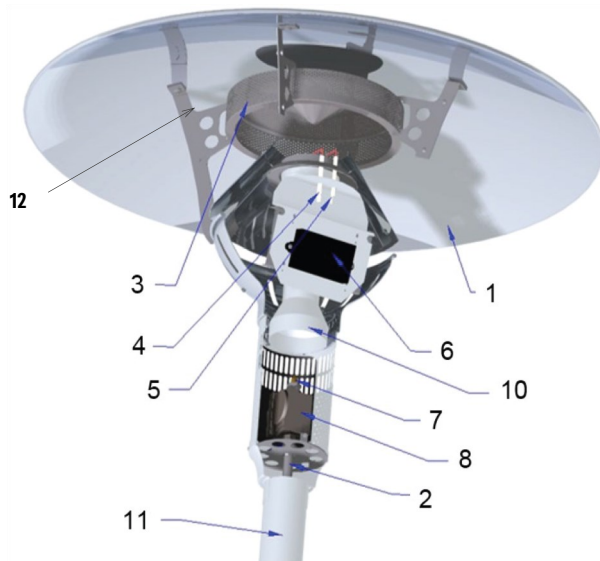

**Model GA301H**

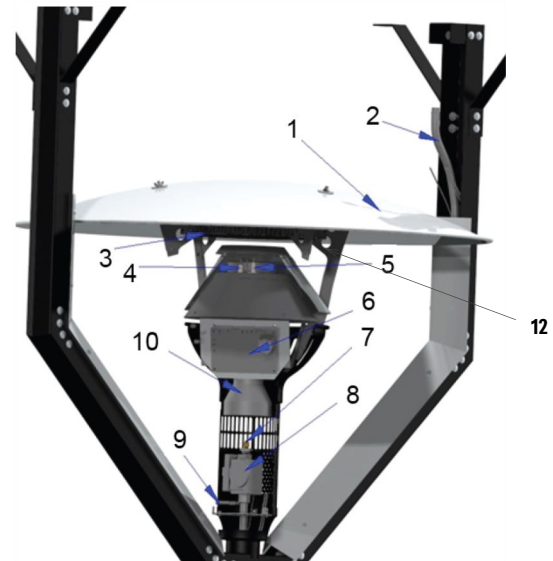

**HEAD OFFICE**

563 Barton Street  
Stoney Creek ON L8E 5S1

**US FACTORY**

315 N Madison Street  
Fortville, IN 46040

**CONTACT US**

1 905 664 9082  
info@irenergy.ca



Series ETS

Built to perform safely and dependably. The **ETS** gas-fired modulating two stage heater is the sleekest tube heater in the market at less than 7" deep delivers a modern, slim heating solution for indoor and outdoor applications.

- Modulating two stage heater
- Wind resistant up to 12 mph
- Effective for ceiling heights 9' to 16'
- Easy to install, maintenance free
- Clearance to combustibles as low as 4"
- Up to 50% electrical energy savings with powerful PSC motor
- Compatible with smart controls
- Approved for outdoor applications

### Confidential USA List Price—Effective Oct 1st, 2024

All ETS heaters are made with Marine Grade Aluminum body and S/S hangers. To order a different finish please follow below index:			MG Aluminum	Black Finish	MG 316 S/S Finish
· ETSxxN(P) or EVxxN(P) - Marine Grade Aluminum · ETSxxN(P)BL or EVxxN(P)BL - MG Aluminum with Black finish skin · ETSxxN(P)MS or EVxxN(P)MS - MG Aluminum with 316 S/S finish					
Part	Length	Description	Price		
<b>ETS40N</b>	9'	<b>ETS</b> Two-stage Heater 40,000 BTU NG (LPG)	\$3,148.70	\$4,202.90	\$4,267.90
<b>ETS50N</b>	9'	<b>ETS</b> Two-stage Heater 50,000 BTU, NG only	\$3,148.70	\$4,202.90	\$4,267.90
<b>ETS60N</b>	12'	<b>ETS</b> Two-stage Heater 60,000 BTU NG (LPG)	\$4,017.00	\$5,443.00	\$5,443.00
<b>ETS80N</b>	17'	<b>ETS</b> Two-stage Heater 80,000 BTU NG (LPG)	\$4,134.40	\$5,602.70	\$5,602.70
<b>ETS100N</b>	17'	<b>ETS</b> Two-stage Heater 100,000 BTU NG (LPG)	\$4,134.40	\$5,602.70	\$5,602.70

**\*Important:** ETS50 only available in Natural Gas

### Optional Hanging Brackets Kit (includes hardware)\* - Purchase separately from the heaters The two digits in the part number represent the length of the heater

<b>ETSCB9S</b>	<b>ETSWB9S</b>	<b>ETSCW9S</b>	<b>ETSCAB9S</b>	<b>ETSCB9BL</b>	<b>ETSWB9BL</b>	<b>ETSCW9BL</b>	<b>ETSCAB9BL</b>
\$88.80	\$86.40	\$109.10	\$86.40	\$103.10	\$113.90	\$143.90	\$113.90
<b>ETSCB17S</b>	<b>ETSWB17S</b>	<b>ETSCW17S</b>	<b>ETSCAB17S</b>	<b>ETSCB17BL</b>	<b>ETSWB17BL</b>	<b>ETSCW17BL</b>	<b>ETSCAB17BL</b>
\$98.30	\$109.10	\$143.90	\$109.10	\$128.30	\$149.90	\$195.40	\$149.90

**Please note:**

\* **9S** and **9BL** brackets suffix for models E40/50/60

\* **17S** and **17BL** brackets suffix for models E80/100

## HEAD OFFICE

563 Barton Street  
Stoney Creek ON L8E 5S1

## US FACTORY

315 N Madison Street  
Fortville, IN 46040

## CONTACT US

1 905 664 9082  
info@irenergy.ca





Series ETSV\*

\* Optional vent adapter to fit any vent accessory in the market

Built to perform safely and dependably. The patent-pending **ETSV** gas-fired modulating two stage heater is the sleekest tube heater in the market at less than 7” deep delivers a modern, slim heating solution for indoor and outdoor applications.

- Modulating two stage heater
- Wind resistant up to 12 mph
- Effective for ceiling heights 9’ to 16’
- Easy to install, maintenance free
- Clearance to combustibles as low as 2”
- Up to 50% electrical energy savings with powerful PSC motor
- Compatible with smart controls
- Ideal for indoor vented or outdoor unvented applications

### Confidential USA List Price—Effective Oct 1st, 2024

All ETSV heaters are made with Marine Grade Aluminum body and S/S hangers. To order a different finish please follow below index:			MG Aluminum	Black Finish
· ETSVxxN(P) or EVxxN(P) - Marine Grade Aluminum · ETSVxxN(P)BL or EVxxN(P)BL- MG Aluminum with Black finish skin				
Part	Length	Description	Price	
ETSV40N	12'	ETSV Two-stage Heater 40,000 BTU NG (LPG), Vented	\$3,331.30	\$4,621.70
ETSV60N	17'	ETSV Two-stage Heater 60,000 BTU NG (LPG), Vented	\$3,645.10	\$5,348.30
ETSV80N	22'	ETSV Two-stage Heater 80,000 BTU NG (LPG), Vented	\$3,974.70	\$6,222.10

### Optional Hanging Brackets Kit (includes hardware)\* - Purchase separately from the heaters

The two digits in the part number represent the length of the heater

ETSVCB12S	ETSVWB12S	ETSVCW12S	ETSV CAB12S	ETSVCB12BL	ETSVWB12BL	ETSVCW12BL	ETSV CAB12BL
\$95.90	\$147.50	\$182.20	\$102.00	\$125.90	\$183.40	\$224.20	\$146.20
ETSVCB22S	ETSVWB22S	ETSVCW22S	ETSV CAB22S	ETSVCB22BL	ETSVWB22BL	ETSVCW22BL	ETSV CAB22BL
\$108.00	\$169.10	\$215.70	\$119.90	\$154.60	\$220.50	\$275.60	\$183.40

Please note:

\* 12S and 12BL brackets suffix for models EV40

\* 22S and 22BL brackets suffix for models EV60/80

## HEAD OFFICE

563 Barton Street  
Stoney Creek ON L8E 5S1











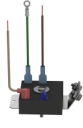

## US FACTORY

315 N Madison Street  
Fortville, IN 46040

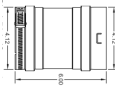
## CONTACT US

1 905 664 9082  
info@irenergy.ca

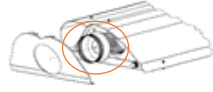
**Optional Accessories – Confidential USA List Price – Effective Oct 1st, 2024**

Image	Part	Description	Price
	<b>CH161</b>	Chain Kit, 20ft	\$76.70
	<b>CH162</b>	Gripple Hanging kit, 15ft	\$25.20
	<b>CG011</b>	Shut-Off Safety Valve 1/2"	\$20.50
	<b>CG012</b>	Gas Flex Connector, 1/2" x 24", Stainless Steel	\$36.90
	<b>CE391</b>	Timer Kit, Cube Relay, 10-20 AMPS Adjustable up to 60 minutes (Field installed)	\$117.50
	<b>CE403</b>	Relay Kit 2-Stage ETS GEN 2, PCB (Field installed) For GEN I heater, please order part No. CE402 (field installed)	\$106.60
	<b>CR011</b>	Vent Terminal with Clamps Exclusively for ETSV	\$24.40
	<b>CS186</b>	4" Vent Adapter - Metal-Fab Exclusively for ETSV	\$115.10
	<b>CT171</b>	4" Vent Adapter Kit - including CS187 Z-FLEX vent adapter and 3 EH013 S/S #8x1/2" screws Exclusively for ETSV	\$115.10
	<b>CT170</b>	Vent Terminal Assembly, 4", Chrome Exclusively for ETSV	\$120.80
	<b>CT175</b>	Vent Terminal Assembly, 4", Painted Hi-Temp Black Exclusively for ETSV	\$152.70
	<b>CS181</b>	Fresh Air Kit, Exclusively for ETSV40	\$98.60
	<b>CS182</b>	Fresh Air Kit, Exclusively for ETSV60/80	\$98.60

## HEAD OFFICE





563 Barton Street  
Stoney Creek ON L8E 5S1

## US FACTORY

315 N Madison Street  
Fortville, IN 46040

## CONTACT US

1 905 664 9082  
info@irenergy.ca

Optional Accessories – Confidential USA List Price – Effective Oct 1st, 2024			
Image	Part	Description	Price
	EE020	Two Stage Control Switch, 24V (fixed mount, 3x3x3") <b>Weather resistant for NEMA-4 Applications</b>	\$328.40
	EE065	Two Stage Control Switch, 24V, <b>1 Switch</b> . Control up to 6 heaters (Ideal for covered patios applications)	\$402.70
	EE066	Two Stage Control Switch, 24V, <b>2 Switches</b> . Control up to 6 heaters (Ideal for covered patios applications)	\$671.40
	EE067	Two Stage Control Switch, 24V, <b>1 Switch, with Timer</b> . Control up to 6 heaters (Ideal for covered patios applications)	\$579.80
	EE068	Two Stage Control Switch, 24V, <b>2 Switches, with Timers</b> . Control up to 6 heaters (Ideal for covered patios applications)	\$962.90

## HEAD OFFICE

563 Barton Street  
Stoney Creek ON L8E 5S1

## US FACTORY

315 N Madison Street  
Fortville, IN 46040

## CONTACT US

1 905 664 9082  
info@irenergy.ca

## Replacement Parts - Confidential USA List Price—Effective Oct 1st, 2024

Item	Part	Description	Price
1	RP-UG107	Valve Train Replacement Kit <b>NG, ETS/ETSV</b>	\$267.00
	RP-UG108	Valve Train Replacement Kit <b>LP, ETS/ETSV</b>	\$267.00
2	RP-CE201	Ignition Module	\$351.80
	RP-CE202	Wire Harness w/5 pin PLUG to Ignition Module	\$39.50
3	RP-CE382	Blower Motor Assembly w/ PSC 2SPD Motor	\$194.30
4	RP-CE058	Transformer, 115V to 24VAC, 40VA	\$45.10
5 (Not Shown)	RP-CE029	<b>For ETS40:</b> Air Switch w/ Bracket, 0.59" W.C.	\$45.00
	RP-CE021	<b>For ETSV40:</b> Air Switch w/ Bracket, 0.55" W.C.	\$91.40
	RP-CE022	<b>For ETS50:</b> Air Switch w/ Bracket, 0.45" W.C.	\$91.40
	RP-CE028	<b>For ETS60 / ETSV60:</b> Air Switch w/ Bracket, 0.78" W.C.	\$55.30
	RP-CE160	<b>For ETS80 / ETS100 / ETSV80:</b> Air Switch w/ Bracket, 0.44" W.C.	\$91.40
6	RP-UG001P	Burner Cup	\$108.00
	RP-CE002	Electrode for Sparking	\$30.60
	RP-CE003	Electrode for Flame Sense	\$29.10
	RP-CE006	Wire, Ignition	\$29.60
	RP-CE036	Wire, Flame Sense	\$21.70
7	RP-CE057	Operation Light, Amber, 28VAC	\$25.20
8	US225ALC	Grill Assembly - Aluminum (Black & Marine Grade S/S options available) *	\$50.30
9	ESCP <sup>IR</sup>	Service Cover Pack (Black & Marine Grade S/S options available) *	\$135.90
10	US234AL	Cowling Aluminum (Black & Marine Grade S/S options available) *	\$79.20
11	RP-CE173	Blower Motor Relay 24V	\$39.70
12 (Not Shown)	RP-CE010	Power Cord	\$31.70

\* The Grill Assembly comes in aluminum. If you would like to order it with a black or marine-grade stainless steel finish, please contact the factory for more information.

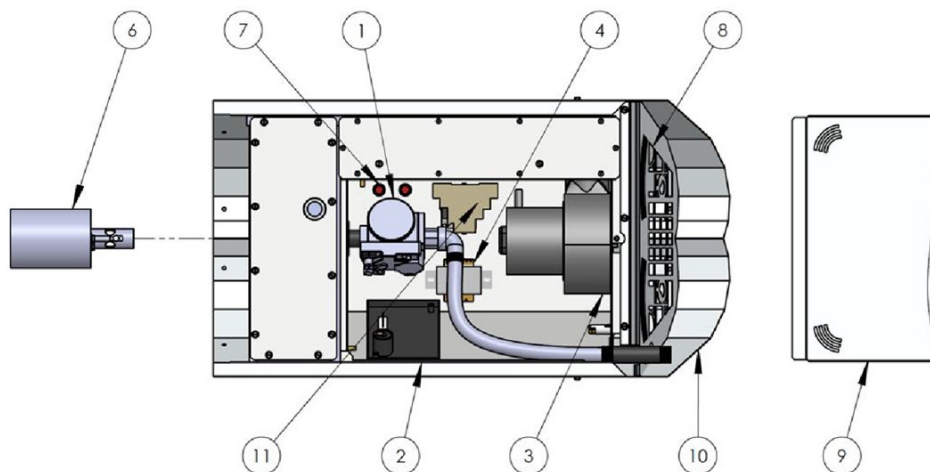

### HEAD OFFICE

563 Barton Street  
Stoney Creek ON L8E 5S1

### US FACTORY

315 N Madison Street  
Fortville, IN 46040

### CONTACT US

1 905 664 9082  
info@irenergy.ca

# the Habanero™

RADIANT PATIO HEATER



- Black Finish - Marine Grade Aluminum Powder Coated with High Temperature Black Paint
- Unvented Natural Gas only

The most powerful spot heating solution in the market

- No blower = No noise
- Polished heat reflector
- Hi/Low/Off Dual heat output control
- Available in 33" and 48" lengths
- As low as 3" top clearance
- New 'High-Grid' technology substantially decreases heat loss
- Protect against flame lift-offs from extreme wind conditions

## Confidential USA List Price—Effective Oct 1st, 2024

	304 Brushed S/S	Black Finish *		
<b>Model M20</b> 33" Lengths 15,000 BTU (low) 20,000 BTU (high)				
SRP Part Number	<b>HAB20NS</b>	<b>HAB20NBL</b>		
List Price	\$2,796.40	\$3,171.60		
<b>Model M40</b> 48" Lengths 32,000 BTU (low) 40,000 BTU (high)				
SRP Part Number (Model M40)	<b>HAB40NS</b>	<b>HAB40NBL</b>		
List Price	\$3,131.60	\$3,713.50		
<b>Model M50</b> 48" Lengths 42,000 BTU (low) 50,000 BTU (high)				
SRP Part Number (Model M50)	<b>HAB50NS</b>	<b>HAB50NBL</b>		
List Price	\$3,131.60	\$3,713.50		
<b>Standard Mounting Kit</b> (Purchase separately from the units) Brush finish with Stainless Unistrut, 2B finish, includes hardware to attach heater and Unistrut to brackets				
SRP Part Number (All models)	<b>HS060S</b>	<b>HS060BL</b>		
List Price	\$435.90	\$341.60		
<b>Ultimate Mounting Kit</b> (Purchase separately from the units) HSXXXS - 304 Stainless Steel Brush Finish with Stainless Unistrut 2B Finish; HSXXXBL - High Temperature Black Powder Coat	 Drawing for M20 Order HS040_	 Drawing for M40/M50 Order HS043_		
SRP Part Number (All models)	<b>HS040S</b>	<b>HS040BL</b>	<b>HS043S</b>	<b>HS043BL</b>
List Price	\$688.80	\$546.30	\$773.90	\$548.70

### HEAD OFFICE

563 Barton Street  
 Stoney Creek ON L8E 5S1

### US FACTORY

315 N Madison Street  
 Fortville, IN 46040

### CONTACT US

1 905 664 9082  
 info@irenergy.ca



**Low Clearance Mounting Kit - Confidential USA List Price – Effective Oct 1st, 2024**

Drawing for M20 Order HS041_		Drawing for M40 and M50 Order HS044_ in addition to Standard/Ultimate Kit	
<b>HS041S</b>	<b>HS041BL</b>	<b>HS044S</b>	<b>HS044BL</b>
<b>(M20)</b>	<b>(M20)</b>	<b>(M40/50)</b>	<b>(M40/50)</b>
\$282.80	\$287.60	\$256.50	\$267.40

HSXXXS - 304 Stainless Steel Brush Finish with Stainless Unistrut 2B Finish; HSXXXBL - High Temperature Black Powder Coat  
Both HS041\_ and HS044\_ Low Clearance kit are horizontal mounting ONLY!

**Optional Accessories - Confidential USA List Price – Effective Oct 1st, 2024**

Image	Part	Description	Price
	<b>SE004</b>	Transformer 120/24V, 20VA for 1 heater Class 2 Not Wet, Class 3 Wet	\$43.30
	<b>SE009</b>	Transformer 120/24V, 40VA for 2 heaters	\$57.60
	<b>SE010</b>	Transformer 120/24V, 100VA for up to 5 heaters	\$149.90
	<b>CG012</b>	Gas Flex Connector, 1/2" x 24", Stainless Steel	\$36.90
	<b>CG011</b>	Shut-Off Safety Valve 1/2"	\$20.50

**HEAD OFFICE**





563 Barton Street  
Stoney Creek ON L8E 5S1

**US FACTORY**

315 N Madison Street  
Fortville, IN 46040

**CONTACT US**

1 905 664 9082  
info@irenergy.ca

Optional Accessories – Confidential USA List Price – Effective Oct 1st, 2024			
Image	Part	Description	Price
	EE020	Two Stage Control Switch, 24V (fixed mount, 3x3x3") <b>Weather resistant for NEMA-4 Applications</b>	\$328.40
	EE065	Two Stage Control Switch, 24V, <b>1 Switch</b> . Control up to 5 heaters (Ideal for covered patios applications)	\$402.70
	EE066	Two Stage Control Switch, 24V, <b>2 Switches</b> . Control up to 5 heaters (Ideal for covered patios applications)	\$671.40
	EE067	Two Stage Control Switch, 24V, <b>1 Switch, with Timer</b> . Control up to 5 heaters (Ideal for covered patios applications)	\$579.80
	EE068	Two Stage Control Switch, 24V, <b>2 Switches, with Timers</b> . Control up to 5 heaters (Ideal for covered patios applications)	\$962.90

**HEAD OFFICE**

563 Barton Street  
Stoney Creek ON L8E 5S1

**US FACTORY**

315 N Madison Street  
Fortville, IN 46040

**CONTACT US**

1 905 664 9082  
info@irenergy.ca

**Replacement Parts - Confidential USA List Price – Effective Oct 1st, 2024**

Item	Part	Description	Price
1	RP-HE001	Spark Electrode	\$108.00
	CE052	Silicone Boot over Electrode Terminal	\$4.70
2	RP-CE006	Ignition Wire (not shown)	\$29.60
3	RP-EE151	Module, potted 24V DSI (Replaces Channel Module 2021-154, 6 pin)	\$171.20
	RP-EE009	Replacement Module Kit Habanero (Replaces Channel Module 2021-96, 5 pin)	\$191.80
4	HG006	Gas Valve NAT - HAB20	\$205.50
	HG007	Gas Valve NAT - HAB40 & HAB50	\$219.30
5	HG003	Burner Assembly HAB-M20	\$1,407.60
	HG004	Burner Assembly HAB-M40 and HAB-M50	\$1,976.70
N/S	RP-HE002	Wire Harness 5 Pin (for Channel Module 2021-96)	\$37.70
	RP-HE006	Wire Harness 6 Pin (for Channel Module 2021-154)	\$41.40

**Important:** EE009 (5-pin) has been discontinued

- The RP-EE009 (6 pin) kit (includes module + wire harness) replacement for HAB heaters purchased **before** Aug. 1, 2021
- The EE151 (6 pin) module is the replacement for HAB heaters purchased **after** Aug. 1, 2021

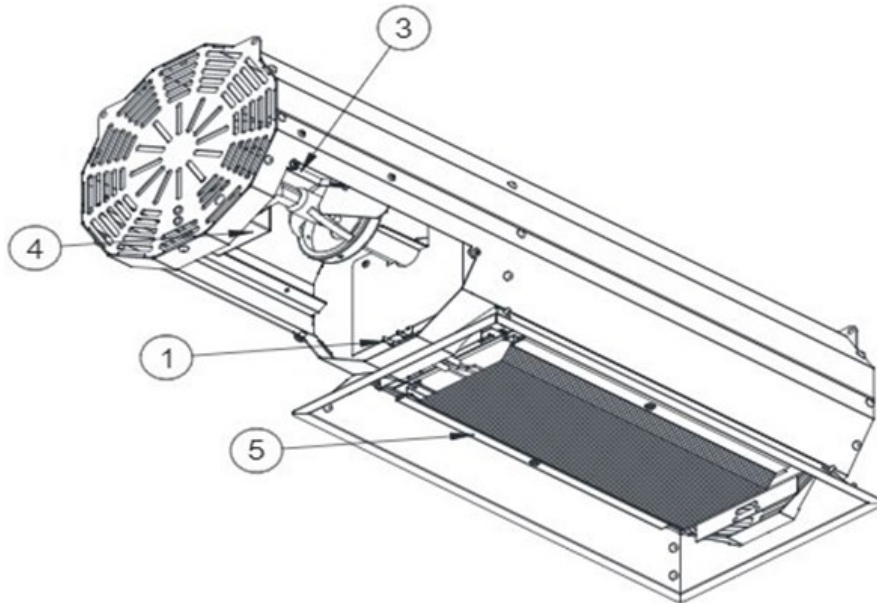

**HEAD OFFICE**

563 Barton Street  
Stoney Creek ON L8E 5S1

**US FACTORY**

315 N Madison Street  
Fortville, IN 46040

**CONTACT US**

1 905 664 9082  
info@irenergy.ca



Long Wave Model

Medium Wave Model

- Modern European design
- High efficiency - even heat pattern
- Corrosion resistant
- Built-in waterproof junction box
- Long & medium energy absorption
- Premium warranty with complete replacement
- Made from 100% recyclable material
- Flexible mounting adjustment from 10 to 50 degree
- Engineered brackets included for easy installation and maintenance
- Compatible with smart technology

## Medium Wave Models

The eWAVE medium wave model combines the elegance of the long wave design with the Schott Nextrema® glass, which provides infrared transparency of almost 90% and is comfortable to the human eye. Certified for indoor and outdoor applications, available at 1800W, 2400W & 120V, or 240V, single phase.



Confidential USA List Price – Effective Oct 1st, 2024												
Part	Price	Dimensions (inches)			Output Wattage	Supply				Weight (lbs)	Remote Control	
		Height	Width	Length		Phase	Amp Draw	Frequency	Voltage			
EW18M12	\$1,140.50	3	10	41	1800 W	1	15 A	60 Hz	120 V	15.7		
EW18M12V	\$1,329.70	3	10	43	1800 W	1	15 A	60 Hz	120 V	16.8	x	
EW18M24	\$1,140.50	3	10	41	1800 W	1	7.5 A	60 Hz	240 V	15.7		
EW18M24V	\$1,329.70	3	10	43	1800 W	1	7.5 A	60 Hz	240 V	16.8	x	
EW24M24	\$1,321.60	3	10	50	2400W	1	10 A	60 Hz	240 V	15.7		
EW24M24V	\$1,491.10	3	10	53.5	2400W	1	10 A	60 Hz	240 V	16.8	x	

- Models ending in **V** include a remote control. Please note residential homes use a single-phase supply 120VAC or 240VAC.

## Long Wave Models

The eWAVE long wave model thick black anodized coating further enhances the performance while protecting against the elements. Certified for indoor and outdoor applications, available heat output settings 1500W, 3000W, 3200W, and 4500W, single or 3 phase.



Confidential USA List Price – Effective Oct 1st, 2024												
Part	Price	Dimensions (inches)			Output Wattage	Supply				Weight (lbs)	Connection	
		Height	Width	Length		Phase	Amp Draw	Frequency	Voltage			
EW15L12	\$936.90	3	8	57	1500 W	1	12.5 A	60 Hz	120 V	16.5		
EW32L24	\$1156.70	3	8	89	3200 W	1	13.3 A	60 Hz	240 V	25.1		
EW30L20Y	\$1355.00	3	10	73	3000 W	3	8.3 A x 3	60 Hz	208 V	27.6	Y	
EW30L24D	\$1355.00	3	10	73	3000 W	3	7.2 A x 3	60 Hz	240 V	27.6	Δ	
EW45L24D	\$1514.20	3	10	96	4500 W	3	10.8 A x 3	60 Hz	240 V	35.9	Δ	
EW45L48Y	\$1514.20	3	10	96	4500 W	3	5.4 A x 3	60 Hz	480 V	35.9	Y	
EW45L48D	\$1665.40	3	10	96	4500 W	3	5.4 A x 3	60 Hz	480 V	35.9	Δ	
EW45L60Y	\$1514.20	3	10	96	4500 W	3	4.3 A x 3	60 Hz	600 V	35.9	Y	
EW45L60D	\$1514.20	3	10	96	4500 W	3	4.3 A x 3	60 Hz	600 V	35.9	Δ	

**Please note:** The majority of residential houses use a single phase supply.

### HEAD OFFICE

563 Barton Street  
Stoney Creek ON L8E 5S1

### US FACTORY

315 N Madison Street  
Fortville, IN 46040

### CONTACT US

1 905 664 9082  
info@irenergy.ca